

ViewStar series

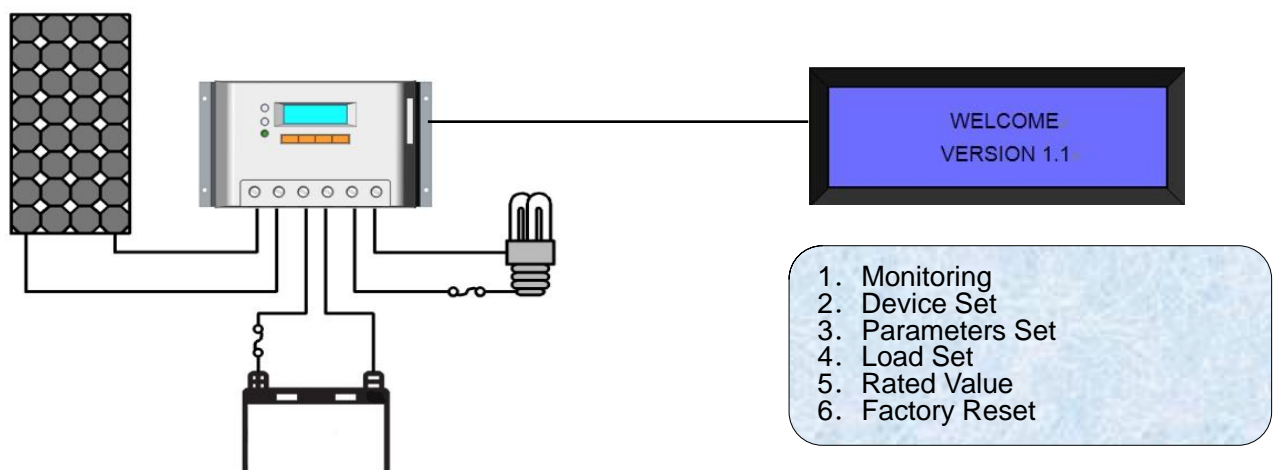

ViewStar series solar controller is our new generation controller for off-grid solar system , such as street light, solar home system or small power station etc., It has LCD display, reliable battery charging, full electronic protection, programmable parameters and other features and powerful function.



ViewStar series

Features:

- ◆ Excellent EMC design
- ◆ 32 bit MCU with high speed
- ◆ High efficient Series PWM charging
- ◆ Gel, Sealed and Flooded battery type option
- ◆ Widely used, automatically recognize day/night
- ◆ 12 bit A/D high-precision sampling to ensure accuracy
- ◆ Use MOSFET as electronic switch
- ◆ Full control parameters setting and modification, diversified load control mode
- ◆ Humanized design of browser interface, undertake every operating conveniently
- ◆ Temperature compensation
- ◆ Adopt graphics dot-matrix LCD screen and HMI (human-machine interface) with 4 buttons, integrated menu displaying and operation
- ◆ Electronic protection: Overheating, over charging, over discharging, overload, and short circuit
- ◆ Reverse protection: any combination of solar module and battery

Technical parameters:

Battery Voltage Parameters (temperature at 25°C)			
Battery charging setting	Gel	Sealed	Flooded
Equalize Charging Voltage	—	14.6V;x2/24V	14.8V;x2/24V
Boost Charging Voltage	14.2V;x2/24V	14.4V;x2/24V	14.6V;x2/24V
Float Charging Voltage	13.8V;x2/24V	13.8V;x2/24V	13.8V;x2/24V
Low Voltage Reconnect Voltage	12.6V;x2/24V	12.6V;x2/24V	12.6V;x2/24V
Low Voltage Disconnect Voltage	11.1V;x2/24V	11.1V;x2/24V	11.1V;x2/24V

Voltage parameters are default value at 25°C, 12V, please use 2X (24V system), 3X (36V system),4X (48V system)

ViewStar series

Specification:

Model No:	VS4024N
Rated Current Load	40A
Nominal System Voltage	12V 24V Auto
Maximum Battery Voltage	32V
Maximum PV Voltage	48V
Rated Battery Current (A)	40A
Charge Circuit Voltage Drop	$\leq 0.24V$
Discharge Circuit Voltage Drop	$\leq 0.16V$
Self-consumption	$\leq 44mA$
Communication	TTL232 level /RJ45 interface(Optional)
Remote temperature sensor interface	2ERJ—3.81
Ground	Negative to the ground
Working temperature	-20°C~ +55°C
Storage temperature	-30°C~ +80°C
Enclosure	IP30
Terminal	35mm ²
Net Weight	0.9kgs