

INSTRUCTION MANUAL

-----For solar charge controller,

-----EPRC series

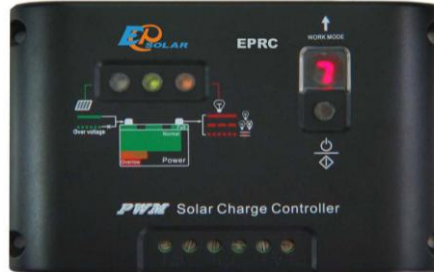

RATINGS (12V or 12/24V auto work)

EPRC-5, 12V or 12/24V auto-work, 5Amp

EPRC-10 12V or 12/24V auto-work, 10Amp

NOTES: For use with solar panels only

TECHNICAL INFORMATION

	12Volt	24Volt
Rated solar input	5/10A	5/10A
Rated load	5/10A	5/10A
25% Current overload	1 min.	1 min.
Load disconnect	11.1V	22.2V
Load reconnect	12.6V	25.20V
Equalization voltage(10 minutes)	14.6v	29.2v
Boost voltage(10 minutes)	14.4v	28.8v
Float voltage	13.6v	27.2v
Temp Comp.(mV/°C)	-30mV	-60mV
Temperature:	-35°C to +55°C	

QUICK START INSTRUCTIONS

This section provides a brief overview of how to get started using the controller. However, please review the entire manual to ensure best performance and years of trouble-free service.

1. Mount the controller to a vertical surface. Allow space above and below the controller for air flow.
2. Make sure the PV and load currents will not exceed the ratings of the controller being installed.
3. It is recommended that the connections be made in order from 1 to 6. (see the following picture)

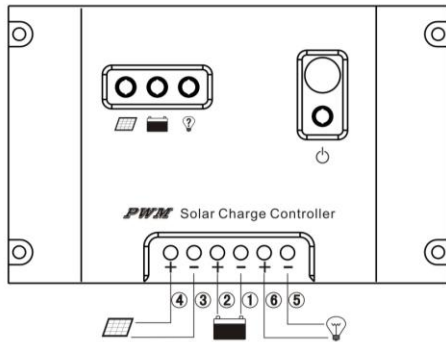

- Use with 12V or 24V batteries only
- Use with 12V or 24V systems only

4. Connect the **BATTERY** first. Use care that bare wires do not touch the metal case of the controller.
5. Connect the **SOLAR**(PV array) next. The green LED indicator will light if sunlight is present.
6. Connect the **LIGHT** last. If the red LED indicator lights, the battery capacity is low and should be charged before completing the system installation
7. Press the **BUTTON** as **6.** or **7.** to verify the system connecting.

LIGHTING CONTROL OPTIONS



8. Press the power switch for 5 seconds, and select the desired LIGHTING CONTROL option. The LED is on, which confirmed you have selected the right one.
9. The controller requires 3 minutes of continuous transition values before it starts to work. These constraints avoid false transitions due to lightning or dark storm clouds.
10. 3 minutes off before the controller start to work.
11. A brief description follows below:

Number 0:	Dusk-to-Dawn, light is on all night
Number 1:	Light is turn on after sundown for 1 hour
Number 2:	Light is turn on after sundown for 2 hours
Number 3:	Light is turn on after sundown for 3 hours
Number 4:	Light is turn on after sundown for 4 hours
Number 5:	Light is turn on after sundown for 5 hours
Number 6:	Light is turn on after sundown for 6 hours
Number 7:	Light is turn on after sundown for 7 hours
Number 0.:	Light is turn on after sundown for 8 hours
Number 1.:	Light is turn on after sundown for 9 hours
Number 2.:	Light is turn on after sundown for 10 hours
Number 3.:	Light is turn on after sundown for 11 hours
Number 4.:	Light is turn on after sundown for 12 hours
Number 5.:	Light is turn on after sundown for 13 hours
Number 6.:	Lights remain turned off, ON/OFF mode
Number 7.:	Test mode, lights on after it detects no light, lights off after it detects light.

LED INDICATOR



- Green ON when solar is charging battery
- Green blink when the system over voltage



Green ON when battery level in the right range
Green slowly flashing when battery level full
Yellow ON when battery level low
Red ON when loads cut off



Red ON when the output is on.
Red slowly flashing when its over load
(the load amps is 1.25 times of rated current for 60 seconds, or the load
amps is 1.5 times of rated current for 5 seconds)
Red blink when the load is short-circuit.

Please note:

the output will cut off once there is over load or short circuit. Disconnect all the equipment and reconnect, and press the button, the controller will resume to work after 10 seconds, or wait for it to work the next day.

TROUBLESHOOTING



1. Charging LED indicator is off when it is daytime
 - a. The green Charging LED should be on if its day time.
 - b. Check that the proper battery type has been selected.
 - c. Check that all wire connections in the system are correct and tight. Check the polarity(+ and -) of the connections
 - d. Measure the PV array open-circuit voltage and confirm it is within normal limits. If the voltage is low or zero, check the connections at the PV array itself. Disconnect the PV from the controller when working on the PV array.
 - e. Measure the PV voltage and the battery voltage at the controller terminals. If the voltage at the terminals is the same(within a few tenths of volts) the PV array is charging the battery. If the PV voltage is close to the open circuit voltage of the panels and the battery voltage is low, the controller is not charging the batteries and may be damaged.
2. Charging LED indicator is blinking
 - a. First check the operating conditions to confirm that the voltage is higher than specifications. Consider the temperature compensation of the controller's PWM setpoint. For example, at 0°C the controller will regulate at about 15.0 volts
 - b. Check that all wire connections in the system are correct and tight.
3. Load LED indicator is blinking, or flashing or on red(load not operating properly)
 - a. Check that the load is turned on. Check that no system fuses are defective.
 - b. Check connections to the load, and other controller and battery connections. Make sure voltage drops in the system wires are not too high.
 - c. If the LED indicator is blinking and no output, check if the load is short-circuit. Disconnect the load, and press the switch button, the controller will return to work after 10 seconds.
 - d. If the LED indicator is flashing and no output, check if the load is over the rated power. Reduce the load, and press the switch button, the controller will return to work after 10 seconds.

INSPECTION AND MAINTENANCE

The following inspections and maintenance tasks are recommended at least once per year for best controller performance

1. Confirm that the correct battery type has been selected.
2. Confirm that the current levels of the solar array and load do not exceed the controller ratings.
3. Tighten all the terminals. Inspect for loose, broken, or burnt wire connections. Be certain no loose strands of wire are touching other terminals
4. Press the TEST button(number: 6. or 7.) to verify the lights are working
5. Check that the controller is securely mounted in a clean environment. Inspect for dirt, insects and corrosion.
6. Check the air flow around the controller is not blocked.
7. Protect from sun and rain. Confirm that water is not collecting under the cover
8. Check that the controller functions and LED indicators are correct for the system conditions at that time.
9. Make sure the PV array is clean and clear of debris and snow. Confirm the array is oriented correctly for the installation location.

SYSTEM MAIN CIRCUIT DIAGRAM

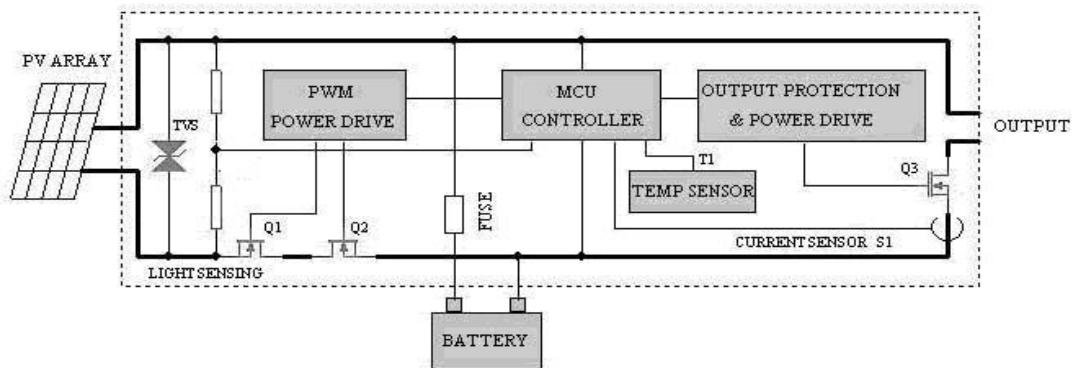

MECHANICAL

